

TRACE LES DIAGONALES

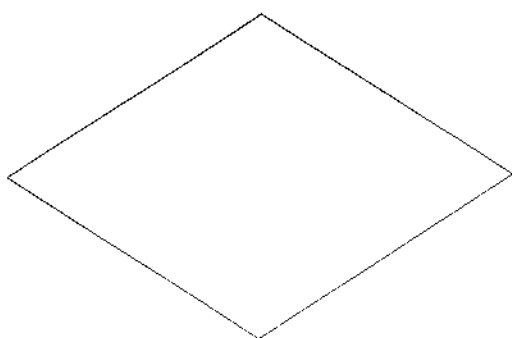
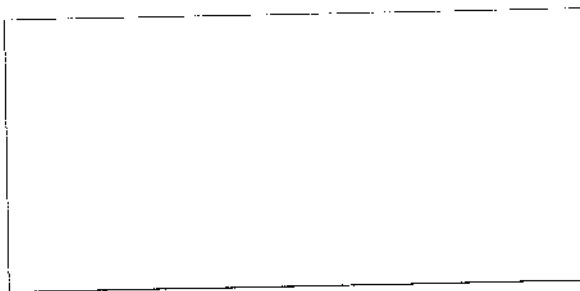
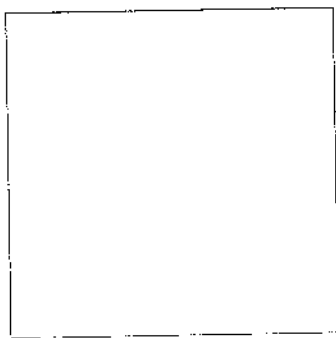

QUESTION

Les diagonales de tous les paralléogrammes ont un point commun.

LEQUEL? (AIDE MIROIR)

.....

.....

.....



СЕРІЙНЕ МАШІНЕ ...
LES DIAGONALES SE COUPENT D'UNE

PARALLELOGRAMME

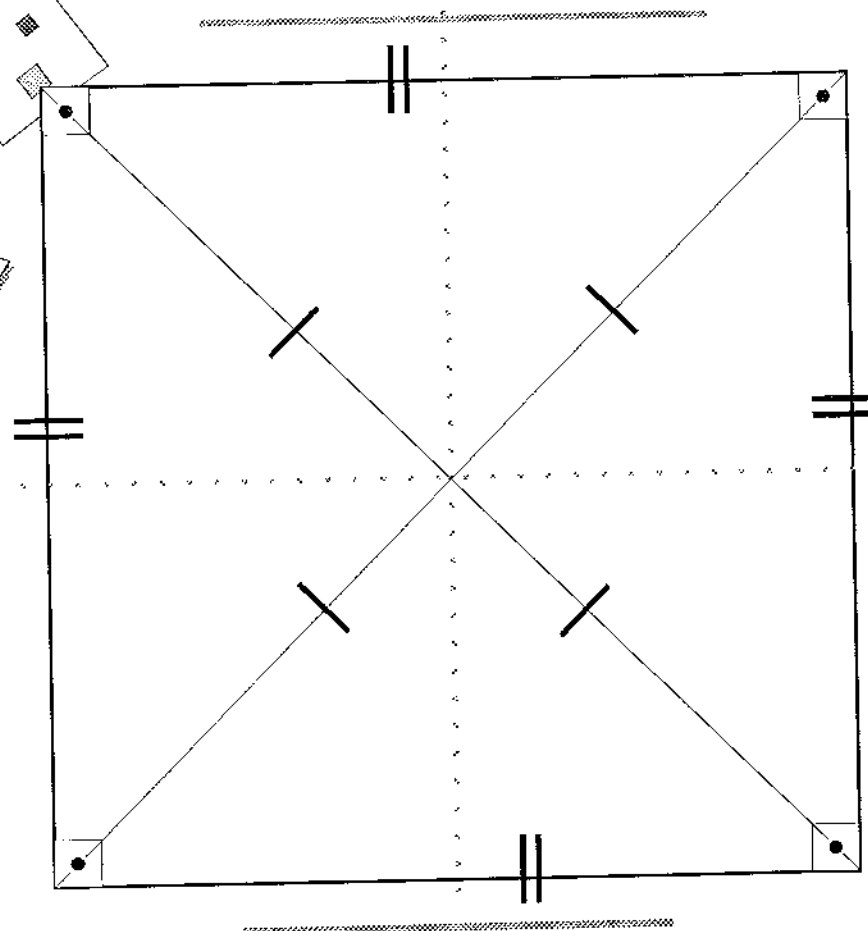
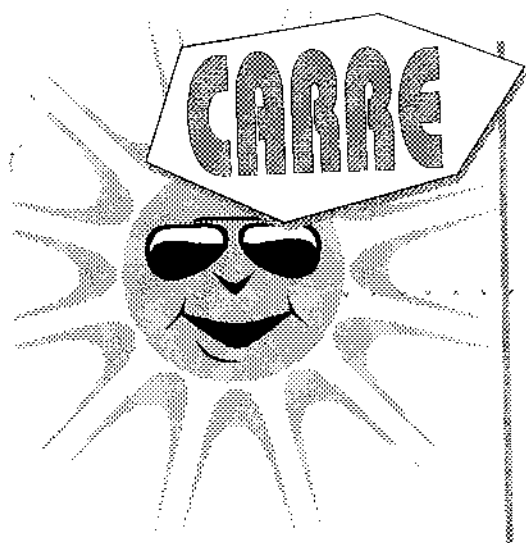
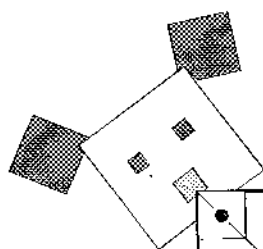
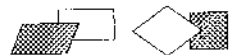

LES CÔTES

1
2

LES ANGLES

1

LES DIAGONALES

1
2

LES AXES DE SYM.

1

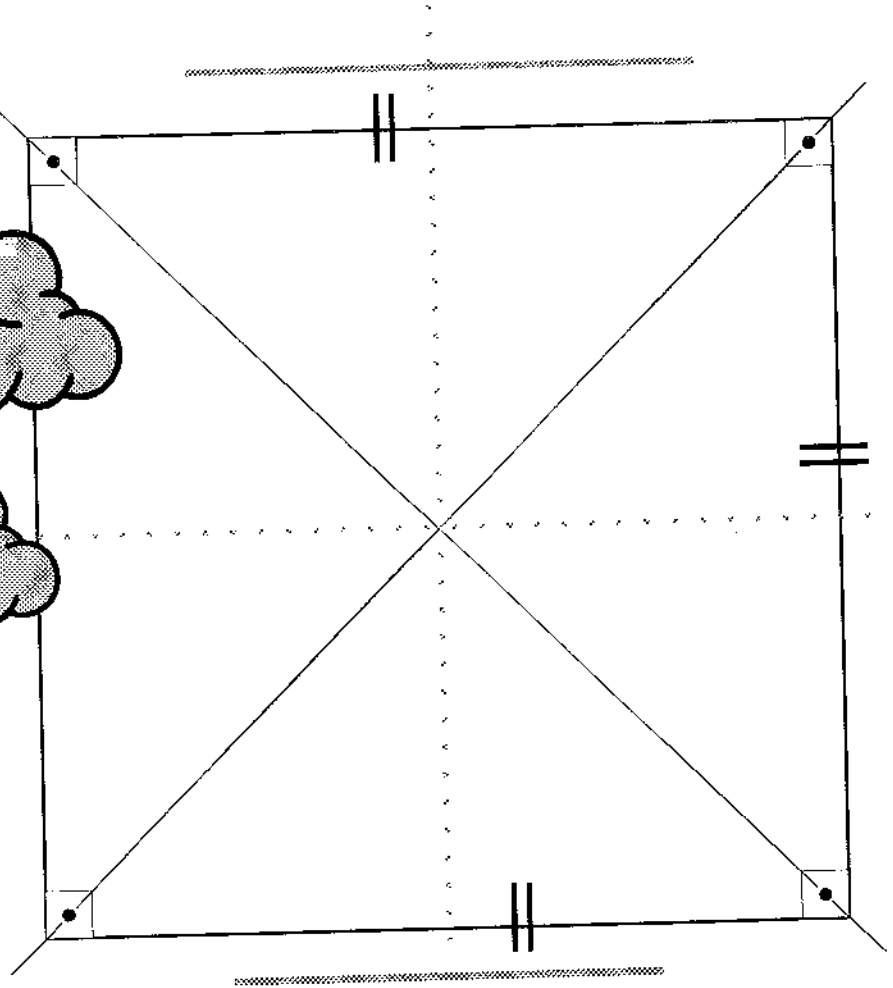
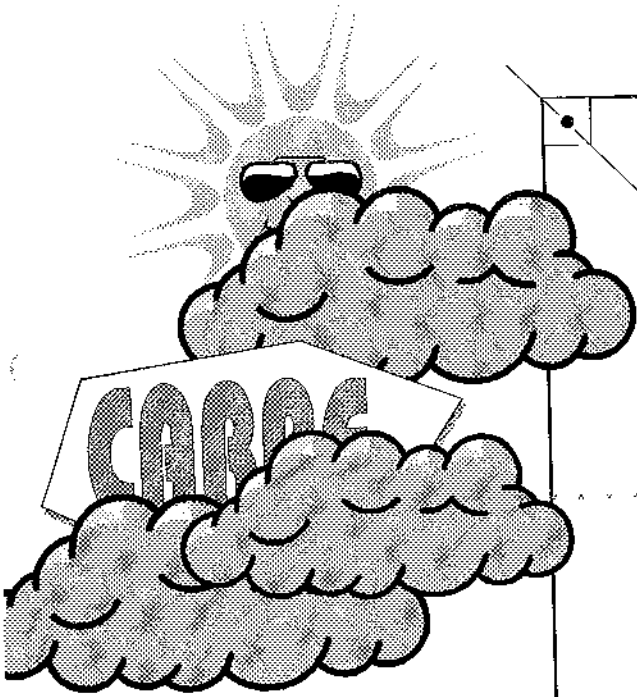

LES COTES 1 _____
 2 _____

LES ANGLES 1 _____

LES DIAGONALES 1 _____
 2 _____
 3 _____

LES AXES DE SYM. 1 _____

PARALLELOGRAMME

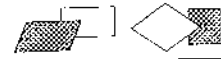

RECTANGLE

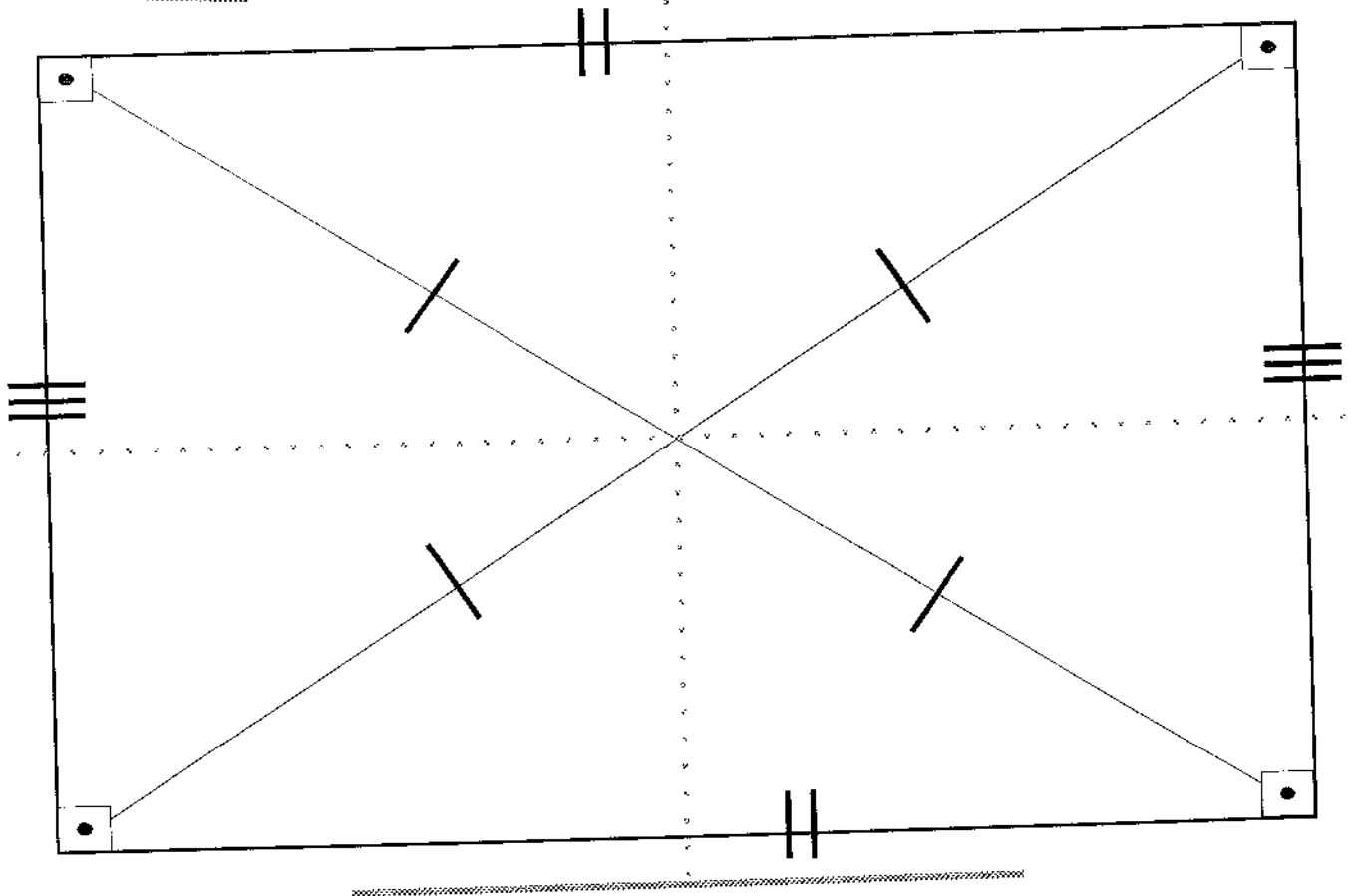

LES COTES

1
2

LES ANGLES

1

LES DIAGONALES

1
2

LES AXES DE SYM.

1

PARALLELOGRAMME

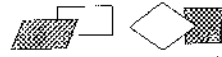

RECTANGLE

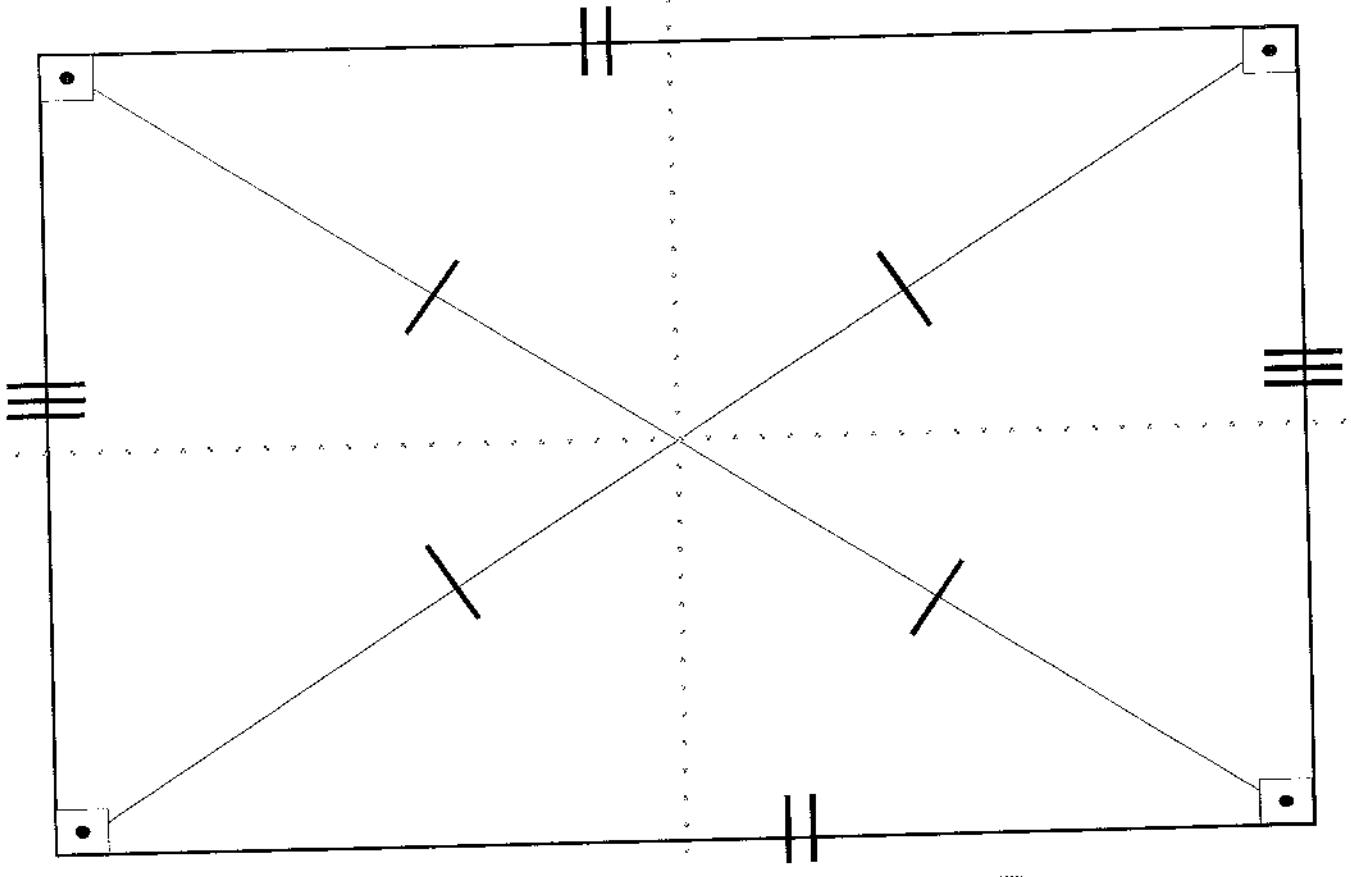

LES COTES

1

2

LES ANGLES

1

LES DIAGONALES

1

2

3

LES AXES DE SYM.

1

MATH.

211

GE

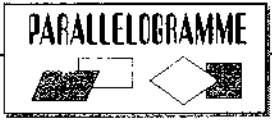

COTES

ANGLES

DIAG.

AXES

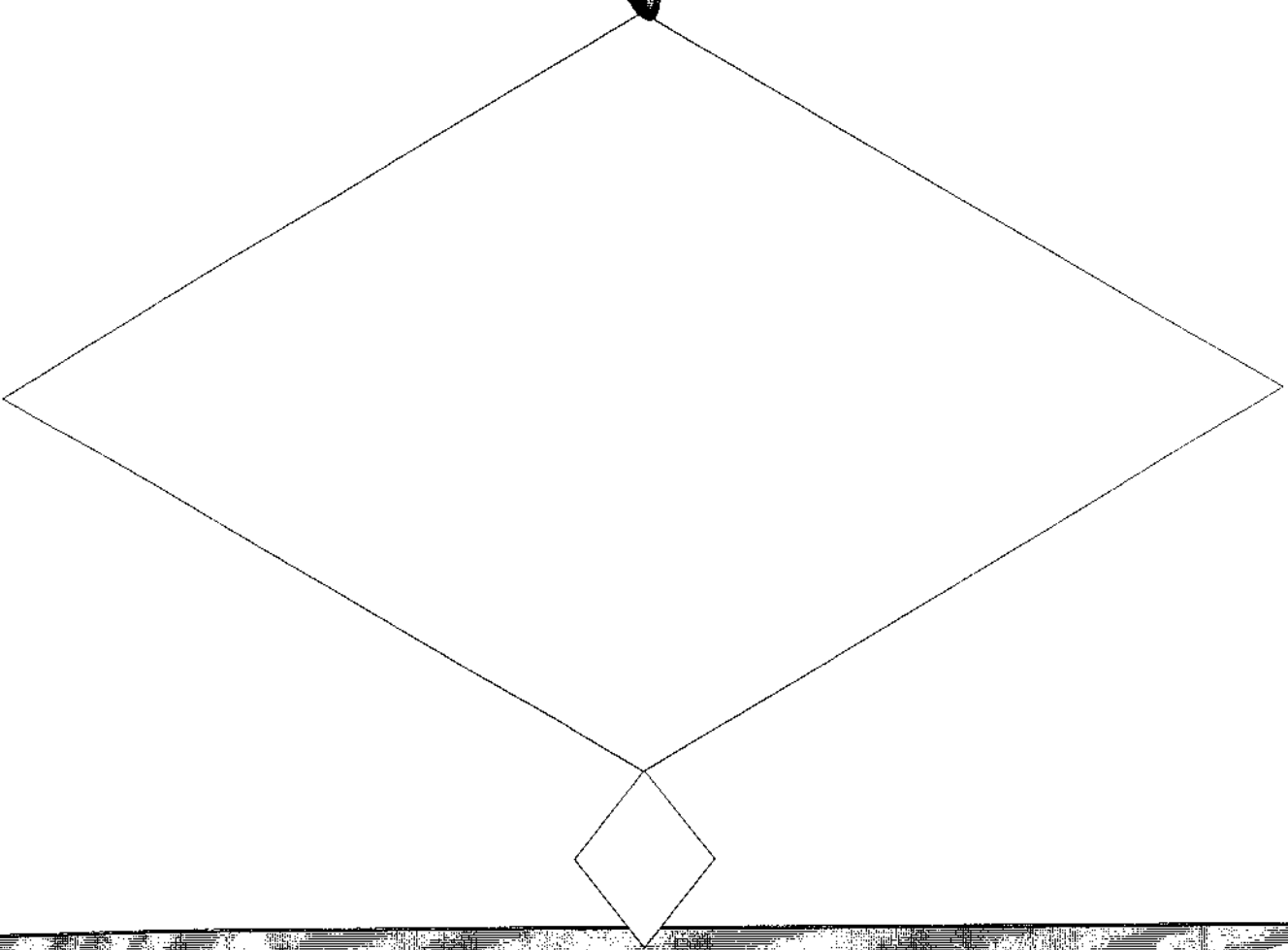

www.les-mathematiques.net

PARALLELOGRAMME

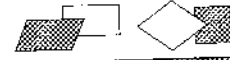

PARALLELOGRAMME

COTES

ANGLES

DIAG.

AXES

RECTANGLE

COTES

ANGLES

DIAG.

AXES

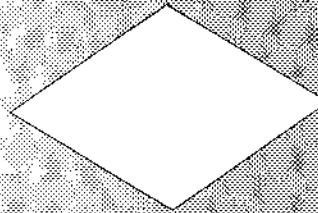
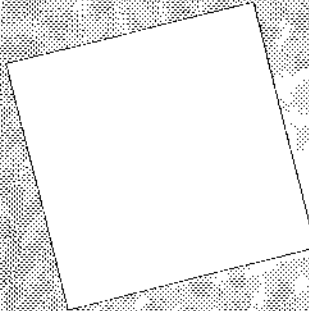
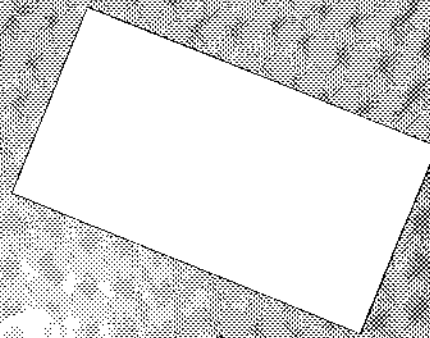
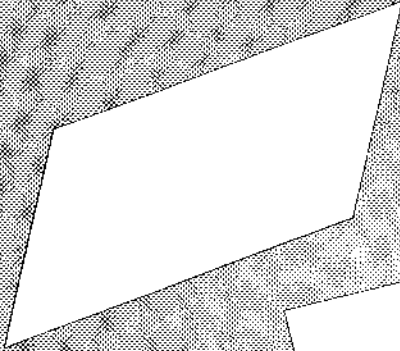

COTES

ANGLES

DIAG.

AXES

COTES

ANGLES

DIAG.

AXES

CARRE

LOSANGE

PARALLELOGRAMME

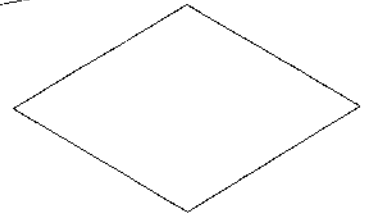
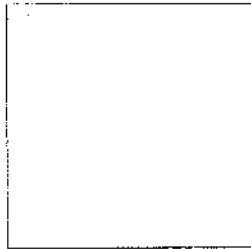
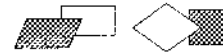

Points communs

Différences

.....

.....

.....

.....

.....

.....

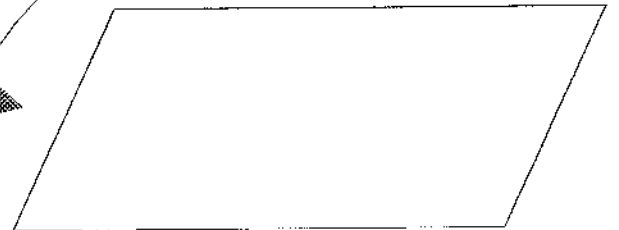
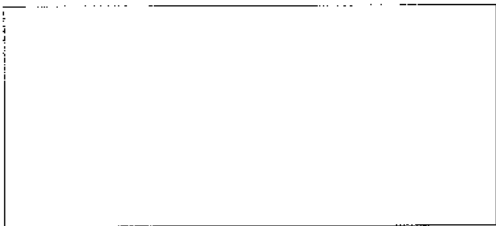

Points communs

Différences

.....

.....

.....

.....

.....

.....

PARALLELOGRAMME

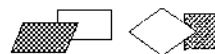

Dessine
les parallélogrammes

DES LOSANGES : l'angle B de ton choix.

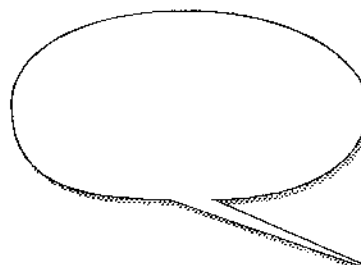
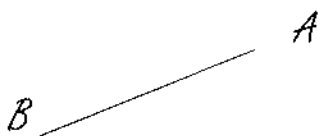
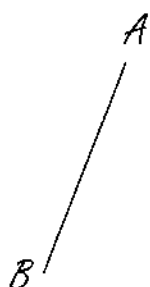

DES LOSANGES : l'angle B = 120 degr.

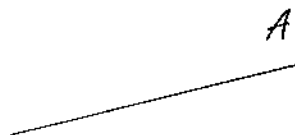

PARALLELOGRAMME

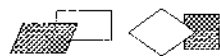

Dessine
les parallélogrammes

DES LOSANGES

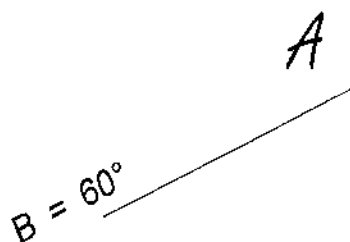
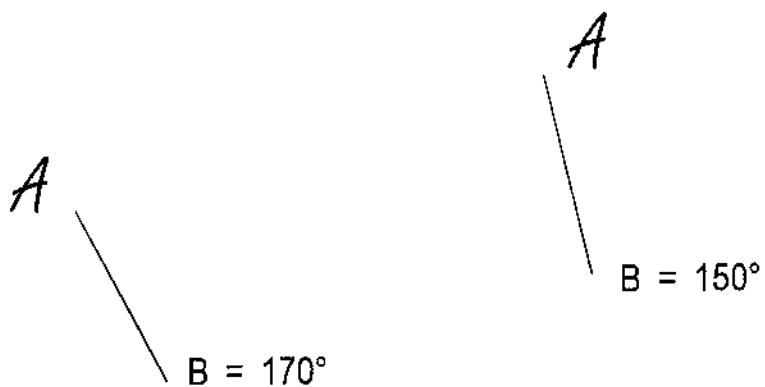
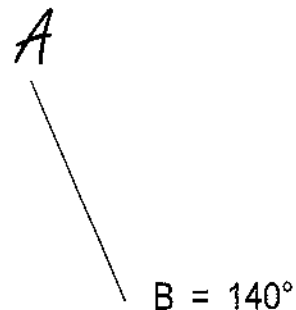
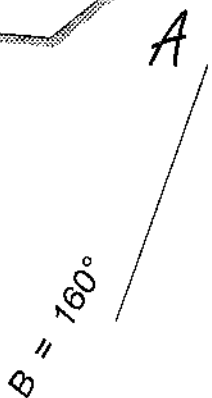
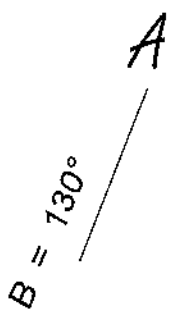

DES LOSANGES : échelle 2:1

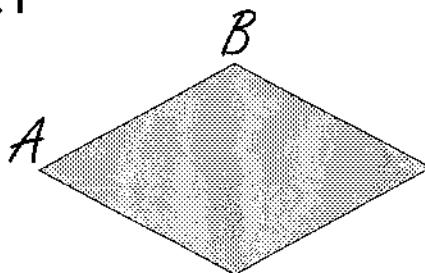
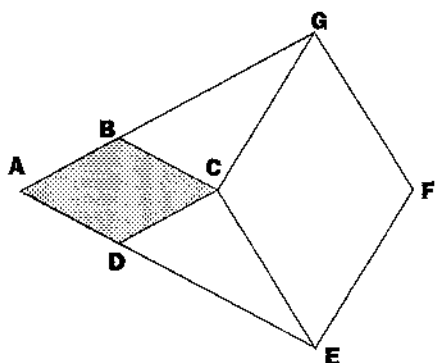

PARALLELOGRAMME

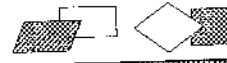

Dessine
les parallélogrammes

DES LOSANGES

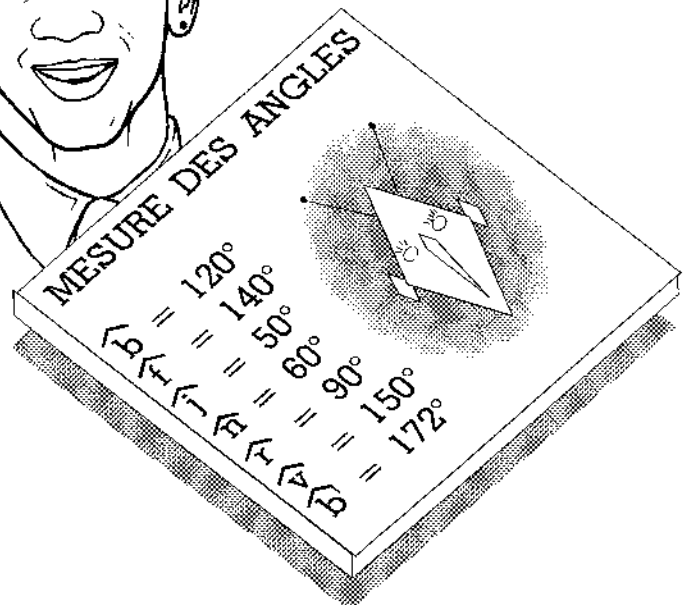
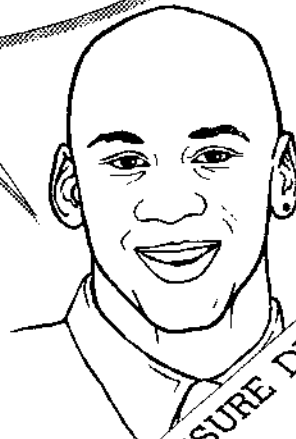
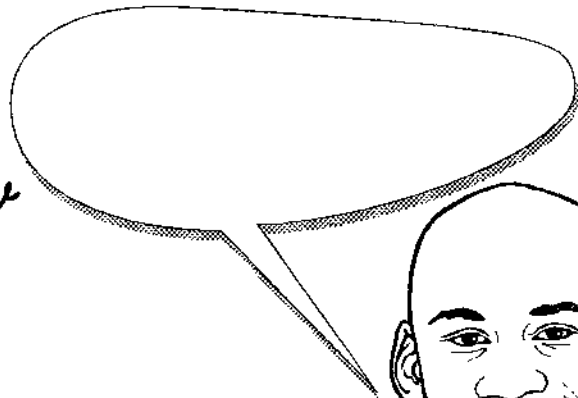
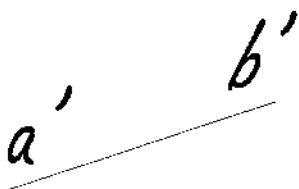
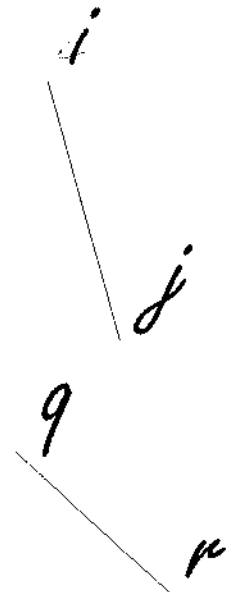
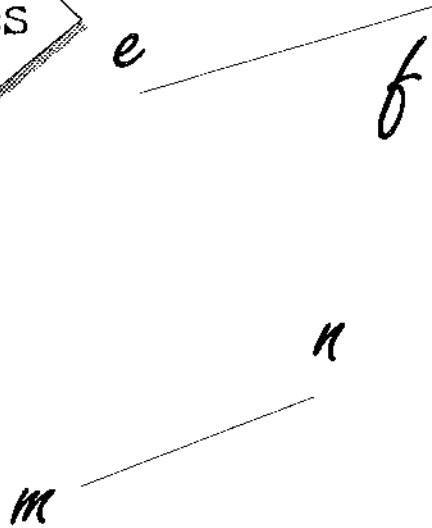
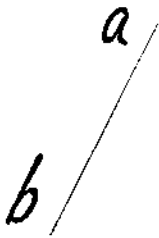



Dessine
les parallélogrammes

e ----- f

DES LOSANGES

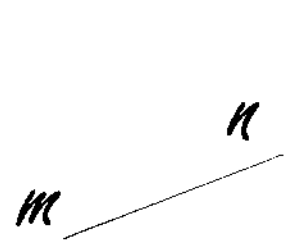
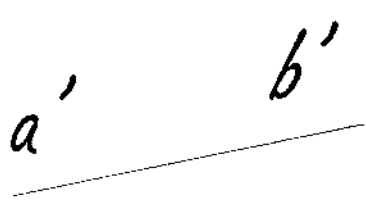
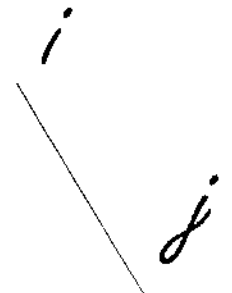
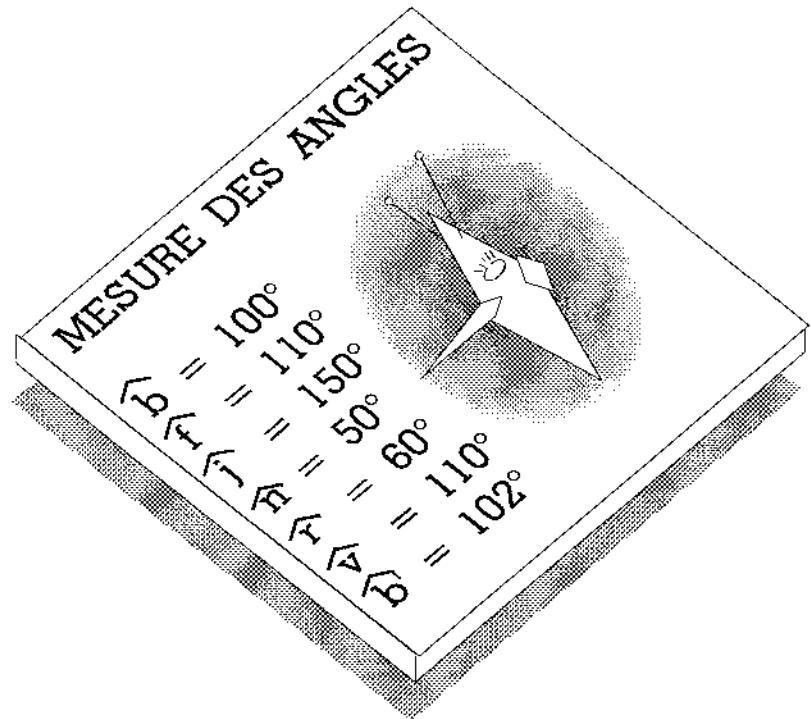



Dessine
les parallélogrammes

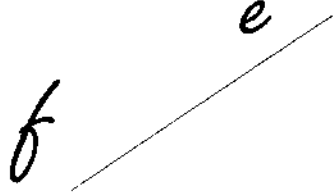

DES PARALLELOGRAMMES

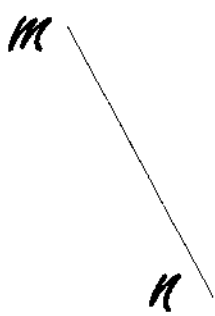
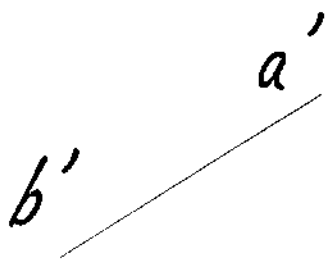
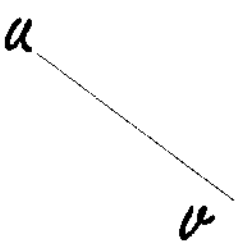
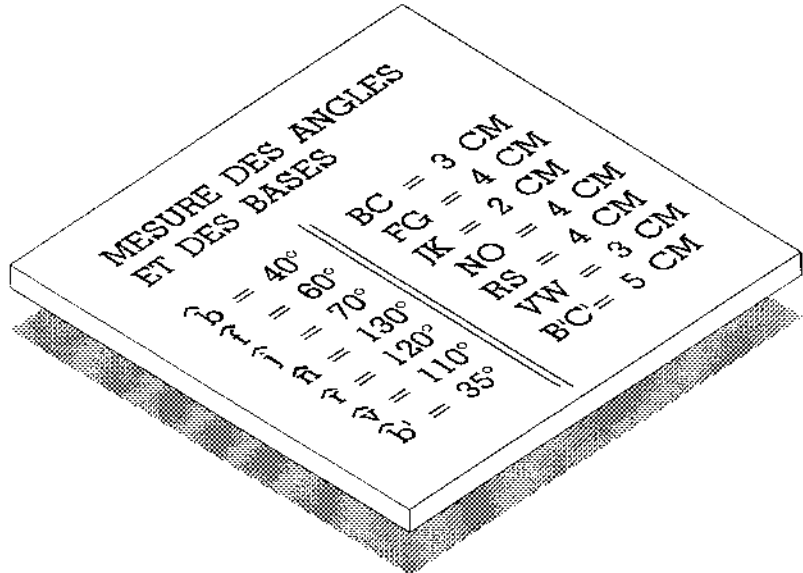
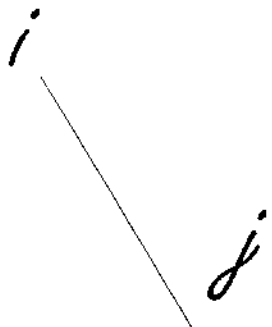
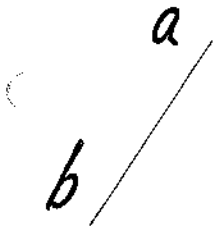

PARALLELOGRAMME

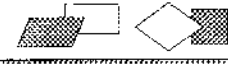

Dessine
les parallélogrammes

DES PARALLELOGRAMMES

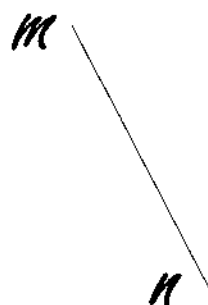
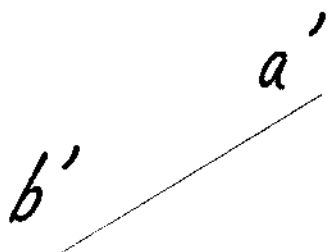
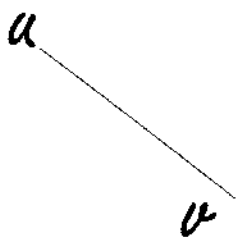
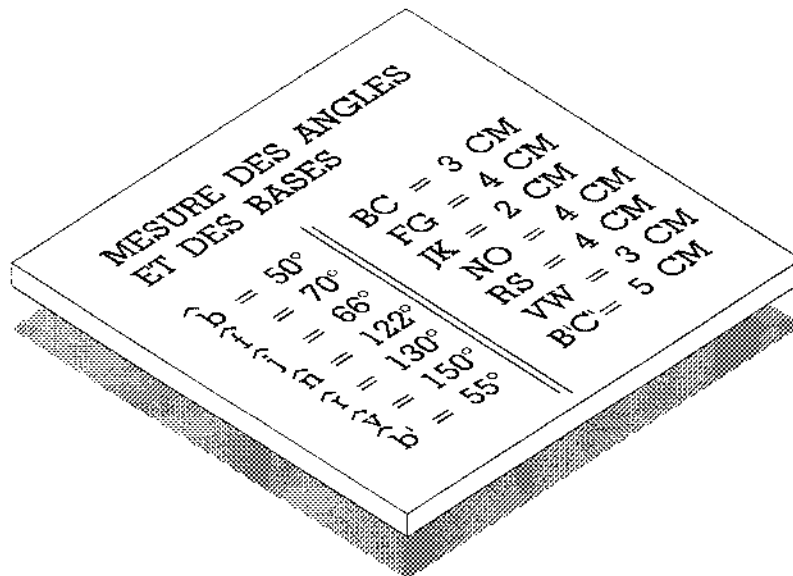
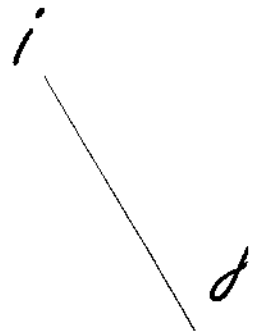
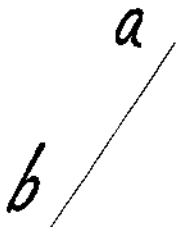
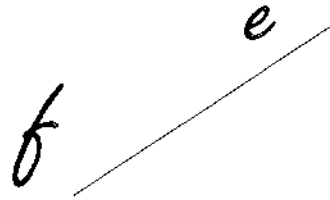

Dessine
les parallélogrammes

PARALLELOGRAMME

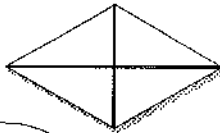
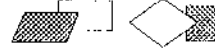

DES LOSANGES
avec les diagonales

les diag. sont

.....
.....
.....
.....

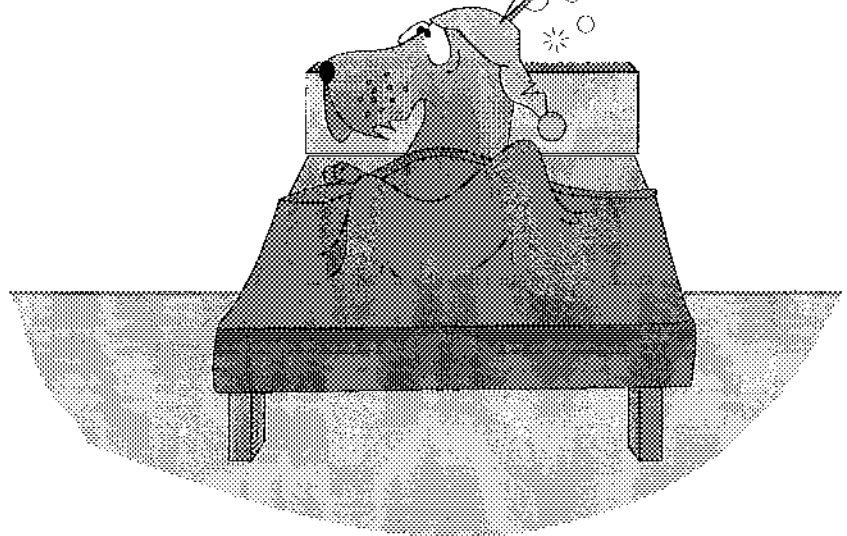
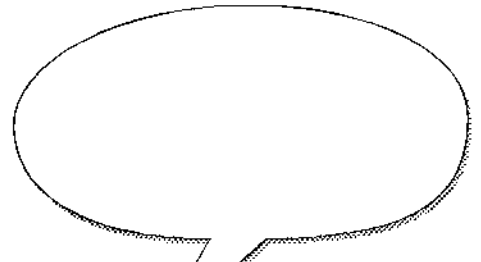
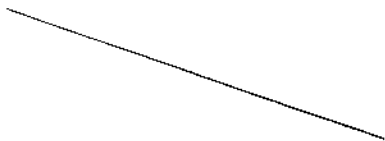
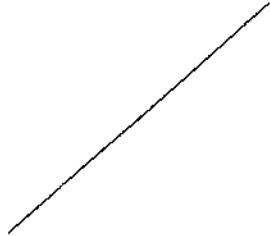
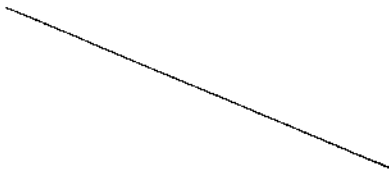
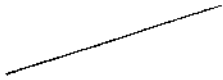

Dessine
les parallélogrammes

PARALLELOGRAMME

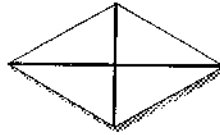
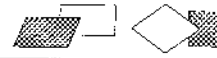

DES LOSANGES
avec les diagonales

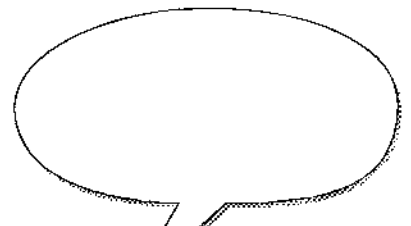
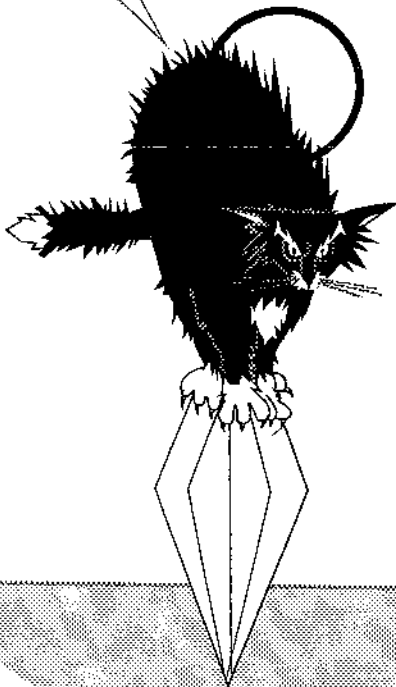

PARALLELOGRAMME

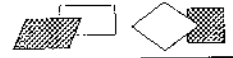

Dessine
les parallélogrammes

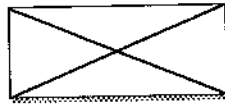

DES RECTANGLES
avec les diagonales

les diag. sont

.....

.....

.....

.....

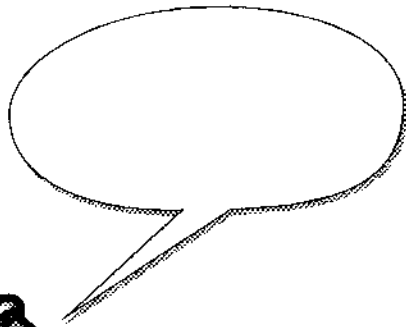
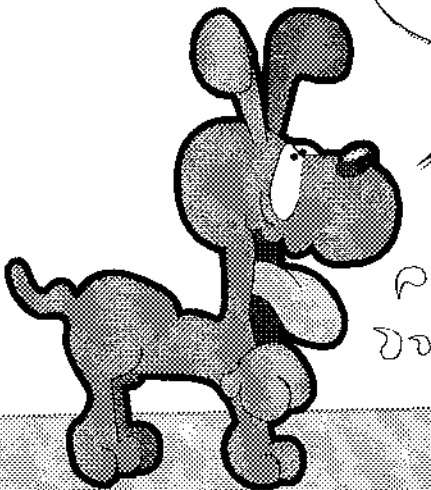
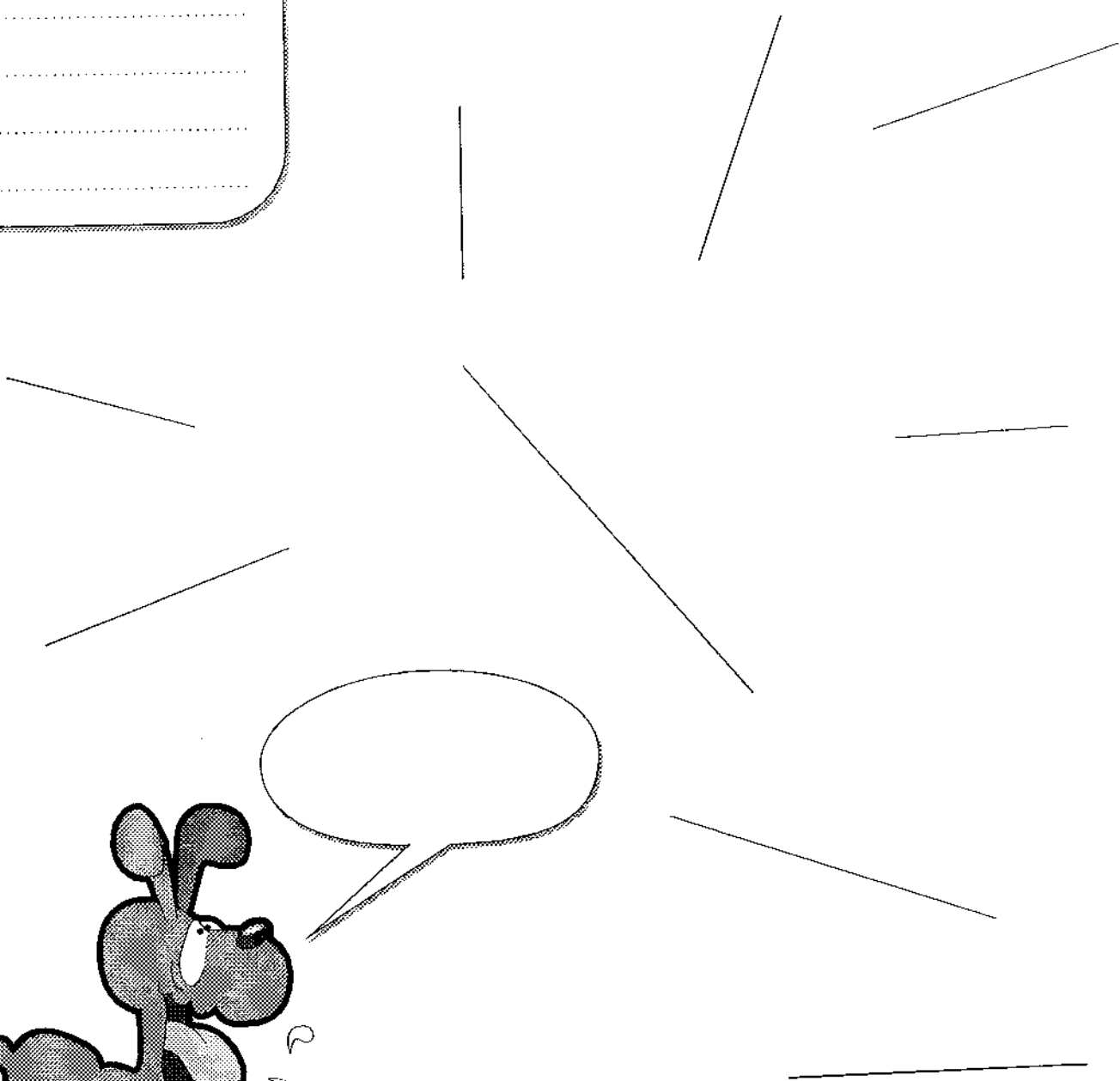

PARALLELOGRAMME



Dessine
les parallélogrammes

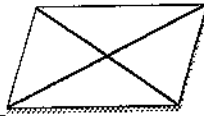

DES PARALLÉLOGRAMMES
avec les diagonales

les diag. sont

.....

.....

.....

.....

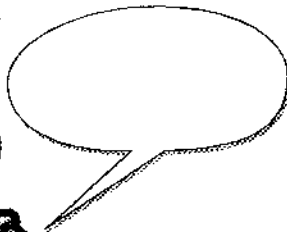
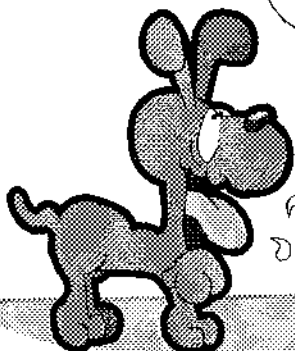
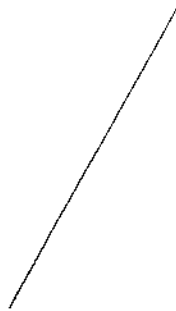
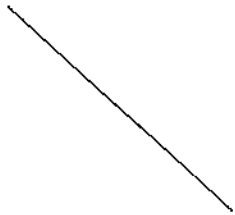
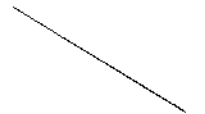
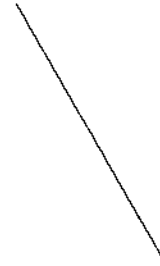

Dessine les parallélogrammes



DES PARALLÉLOGRAMMES
avec les diagonales

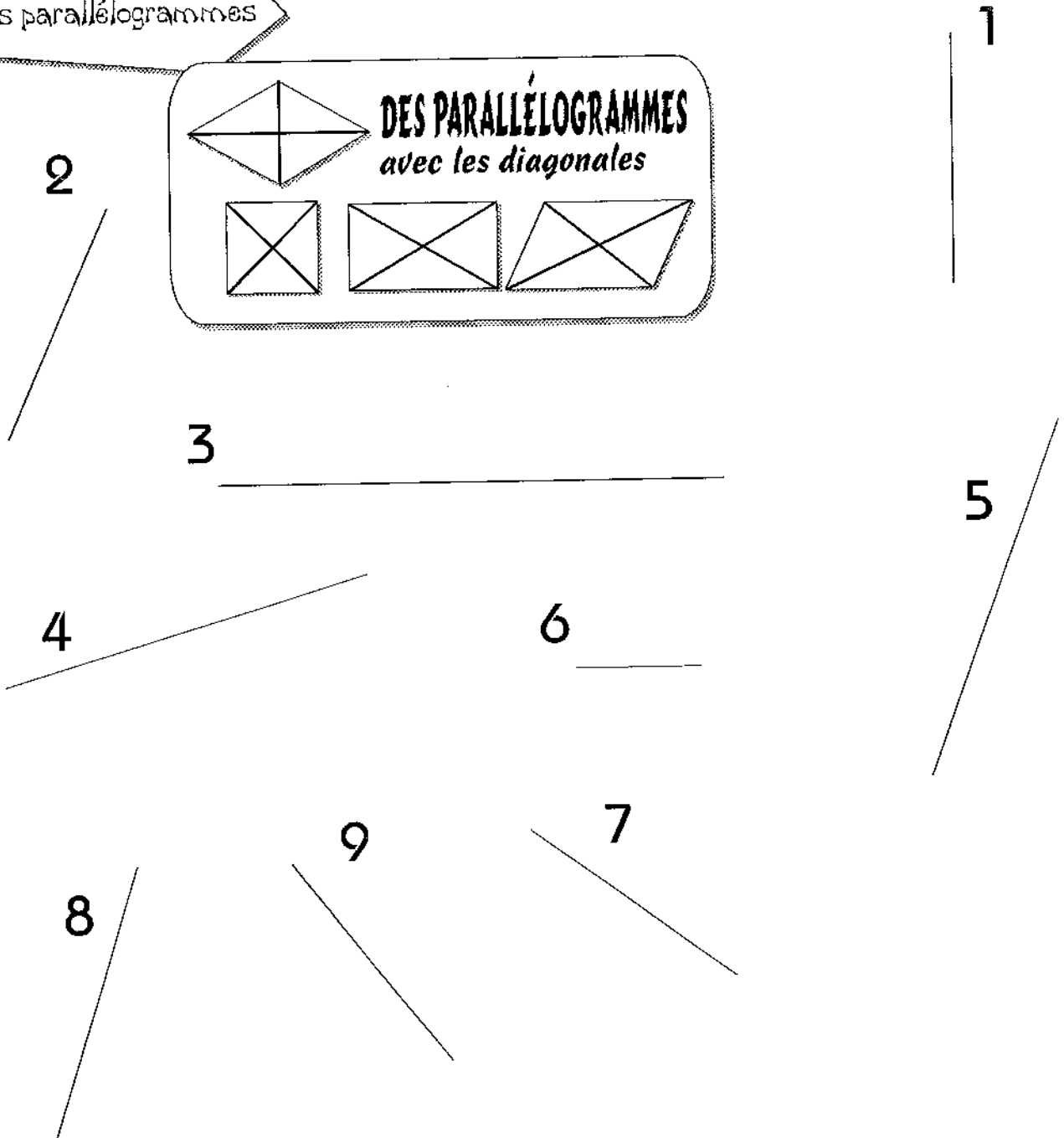

| 1 | 2 | 3 | 4 | 5 | 6 | 7 | 8 | 9 | 10 | |
|---|---|---|---|---|---|---|---|---|----|------------|
| | | | | | | | | | | carré |
| | | | | | | | | | | rectangle |
| | | | | | | | | | | losange |
| | | | | | | | | | | parallélo. |

10